

REV	ECN	SIGN	DATE	DESCRIPTION
1.0	V0	K. ZHAO	05/21/2021	

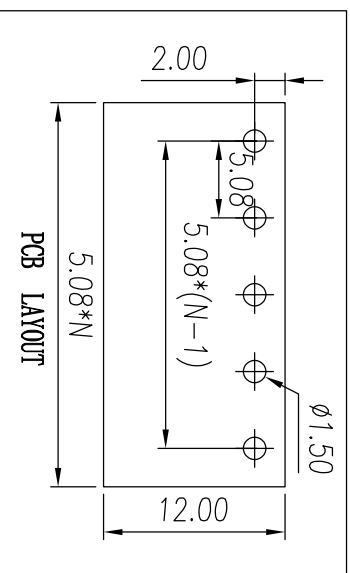
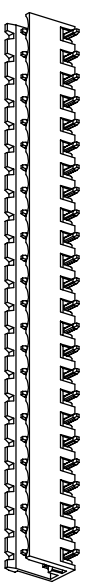

NOTES:

1. UL Standard

Application	B	C	D
Rate voltage(V)	300	/	300
Rate current(A)	15	/	10
Rate impulse voltage(KV)	1.6		

2. IEC Standard

Pollution degree	2	2	3
Overvoltage category	II	III	III
Rate impulse voltage(KV)	4	4	4
Rate voltage(V)	320	320	250
Rate current(A)	15		

- Pitch : 5.08 mm
- Operating temperature:  $-40^{\circ}\text{C}\sim+105^{\circ}\text{C}$
- RoHS Compliance
- Material: Housing PA66, UL94V-0
- Pin copper alloy, Sn plated

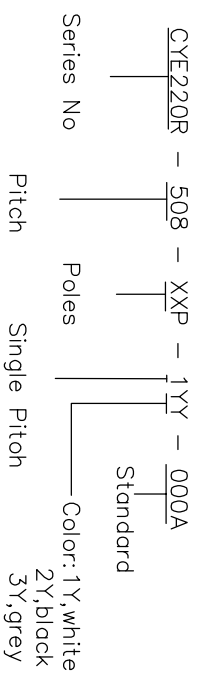
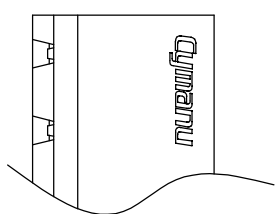
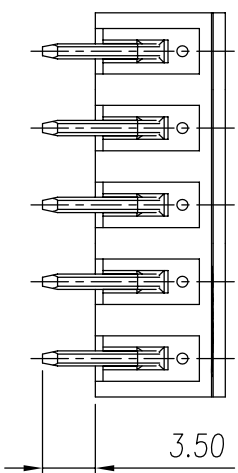
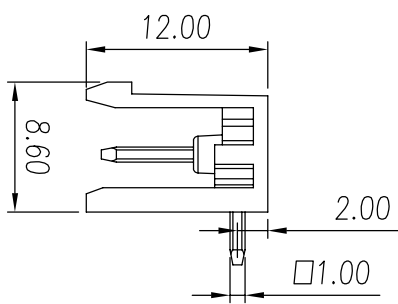
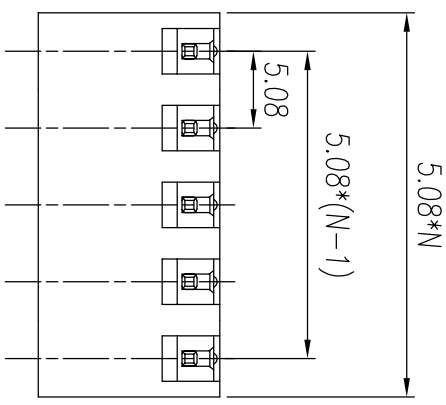

Remark: This drawing is a controlled document for Cymannu. All specifications are subject to change without prior notice.

	linear dimension								≡	—	□	//	⊥
variable range	to 10	over 18 to 30	over 30 to 50	over 50 to 80	over 80 to 120	over 120 to 160	over 160 to 200	all	to 5	over 5 to 30	over 30 to 120	over 120 to	
tolerance	±0.15	±0.25	±0.35	±0.45	±0.60	±0.75	±0.90	0.5	0.025	0.06	0.12	0.4	

SIZE: A4	SCALE: 2:1	DATE: 05/21/2021	DATE: 05/21/2021
UNTT: mm	SHEET: 1/1	APPROVED: H. JIANG	DATE: 05/21/2021
DRAWN: K. ZHAO	CHECKED: C. LU	PART NO.: CYE220R-508-XXP-1YY-000A	TITLE: Plug in connector

NINGBO CHANGYU ELECTRONICS MANUFACTURING CO., LTD  
Email: sales@cymannu.com WWW.CYMANNU.COM